

Badger

Installation Guide



Before using your Badger, download the app.



Scan the QR code with your phone or go to
www.satellitedisplay.com/app

What's In Your Box?

1 Badger

2 Magnet
Clip

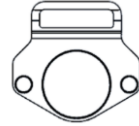

3 Clear Badge
Holder



Attaches to
magnet clip

4 Micro USB
Charging Cord

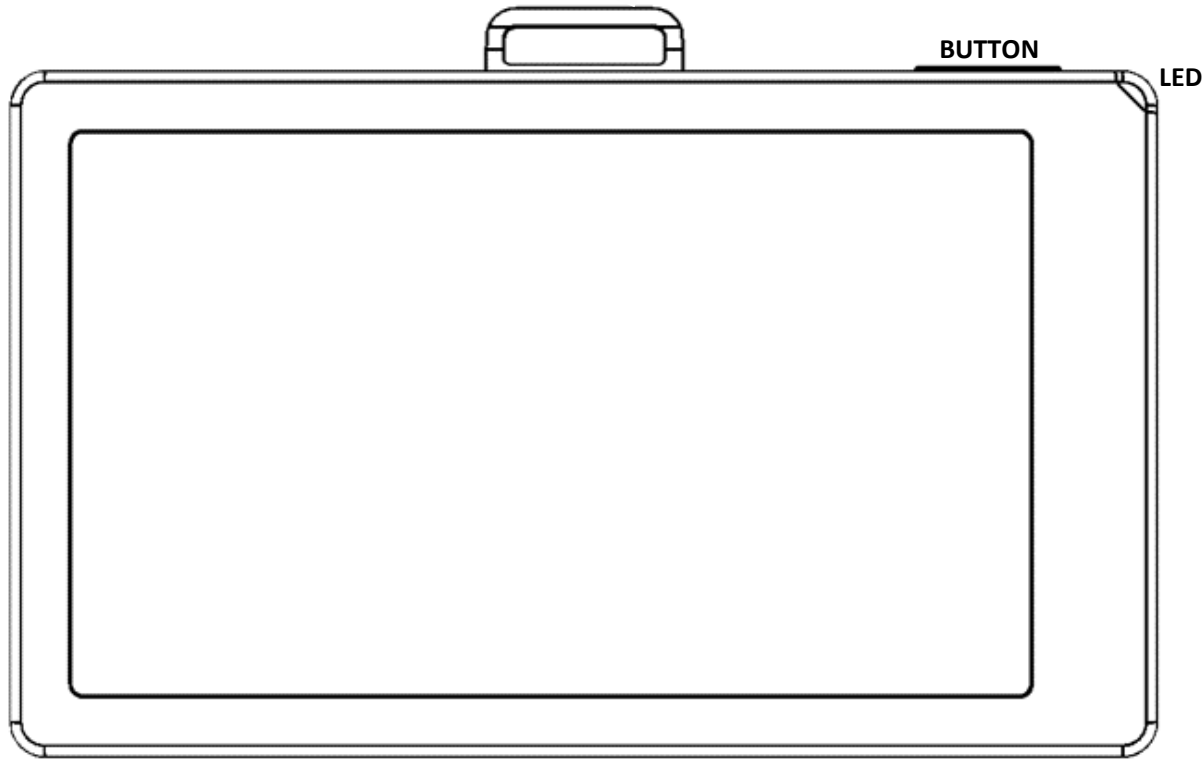

Turning Badger On

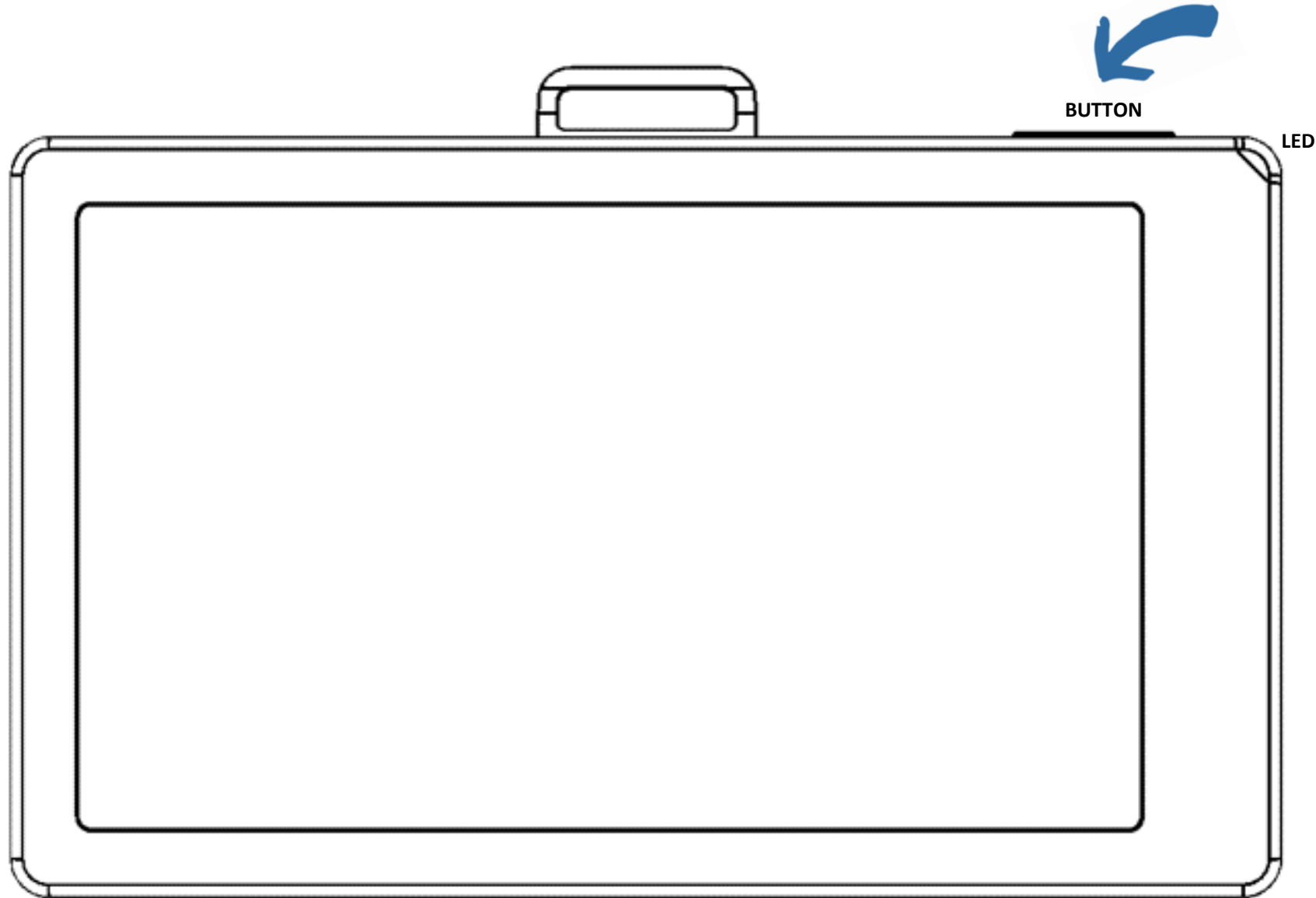

CLICK the Button
Less than 1 second

Screen will clear
and LED light will flicker

Green

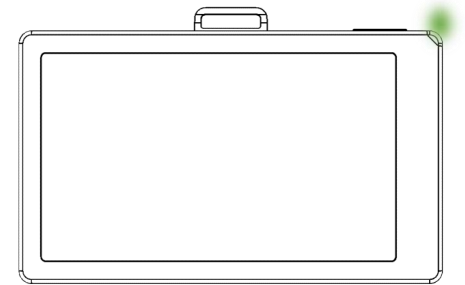

Turning Badger Off

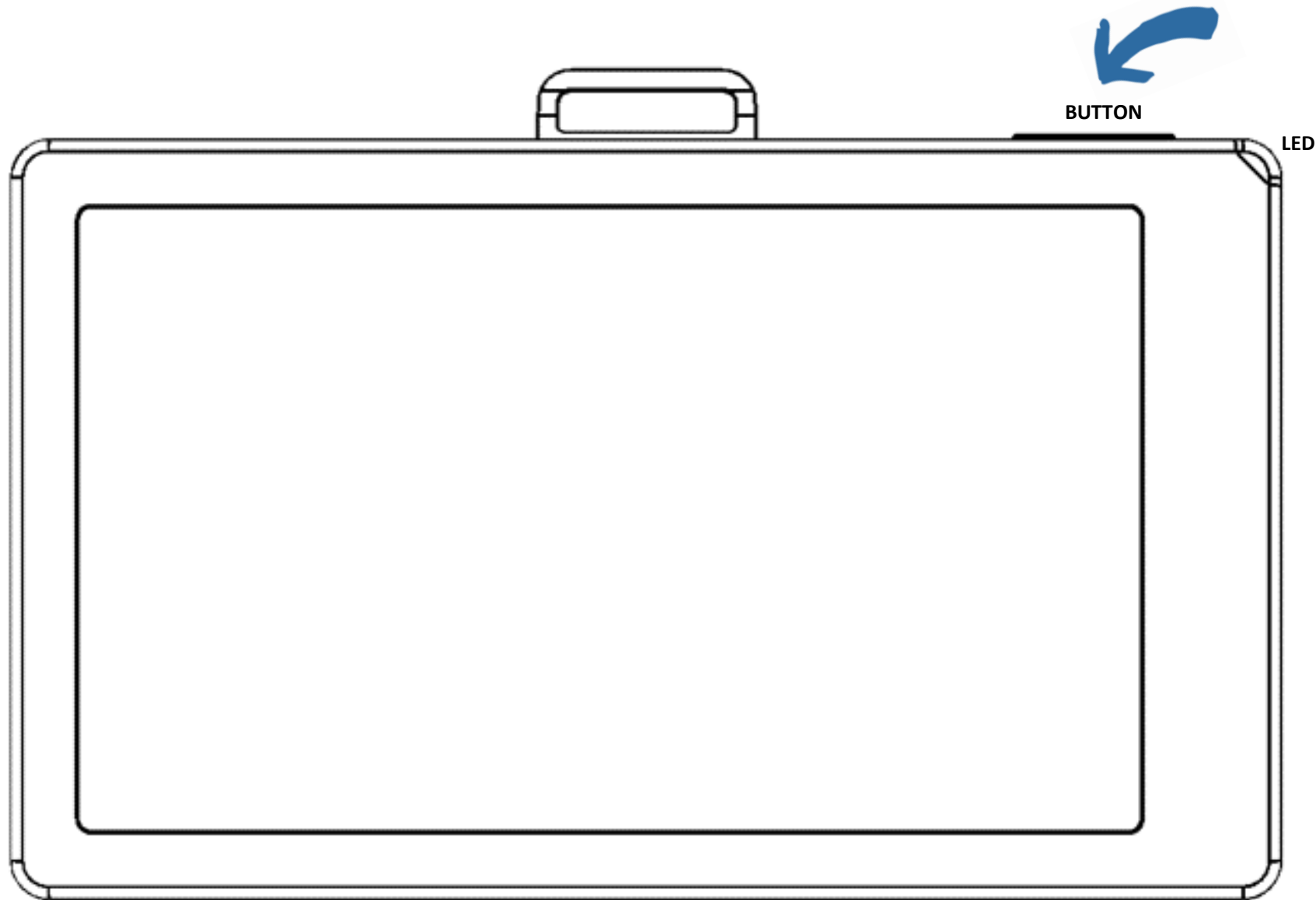

HOLD the Button
More than 2 seconds

LED light will
stop flickering

Connecting To Badger

IMPORTANT!

Bluetooth must be **turned on** in your phone settings before using the Badger App

NOTE: Do not “pair” Badger in your phone’s Bluetooth menu. Badger must be paired through the Badger App.

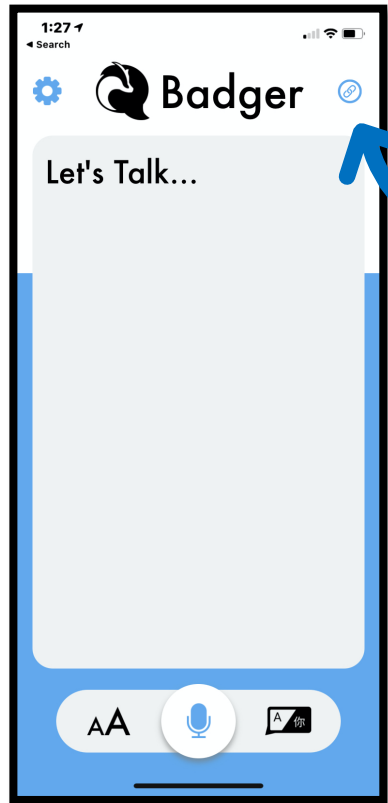

Tap Here



CONNECT
ICON

to access the
Connect Page

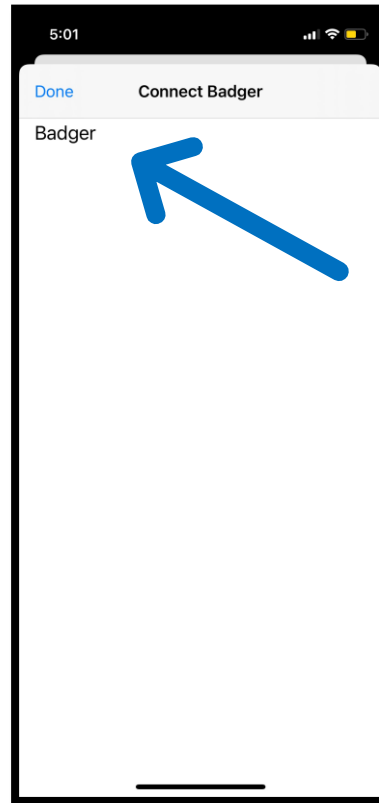

Tap “Badger”

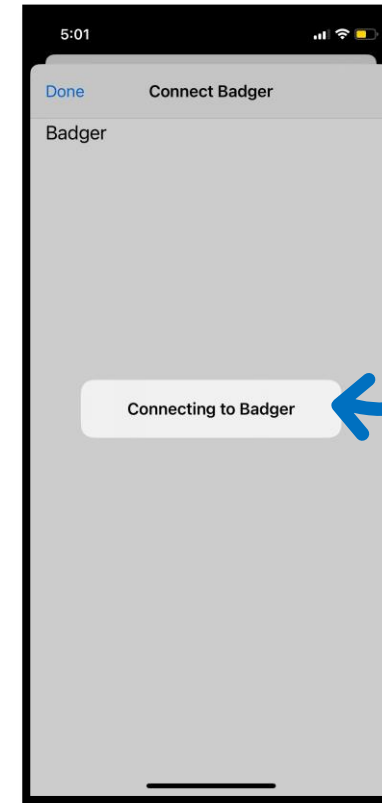

When the
“Connecting to Badger”

dialog box
disappears,
you’re
connected!

Start Captioning

Tap Here



MICROPHONE
ICON

to begin
captioning

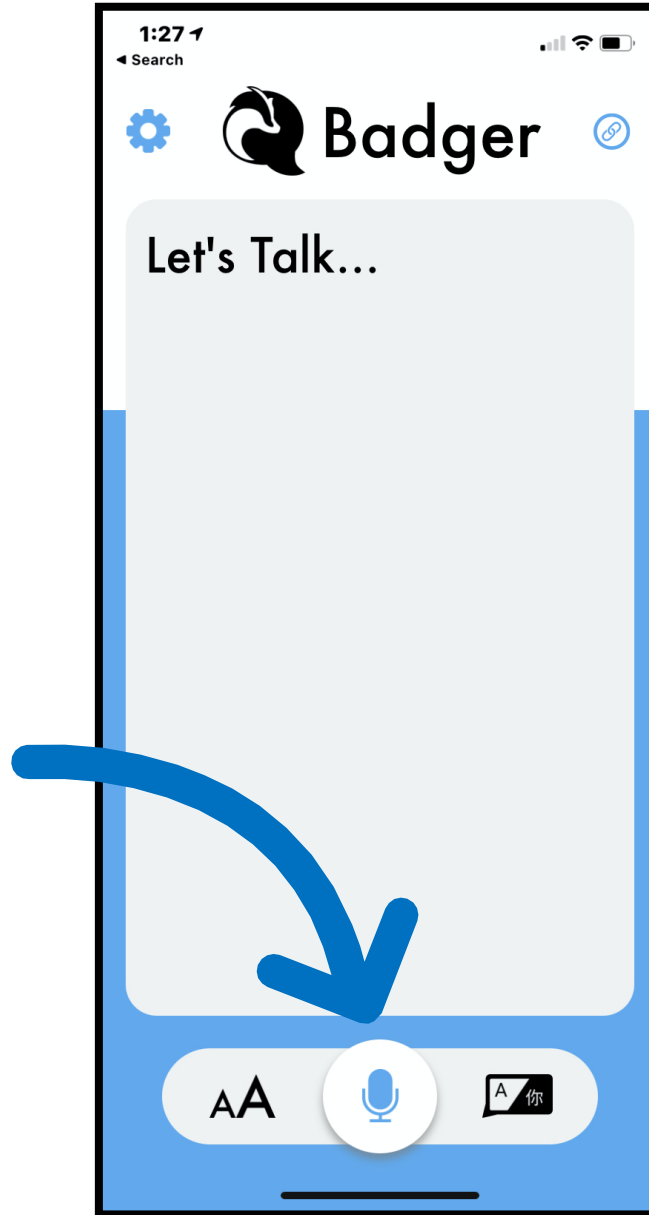

Default Settings

Tap Here

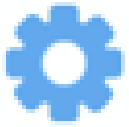

SETTINGS
ICON

to access the
Settings Page

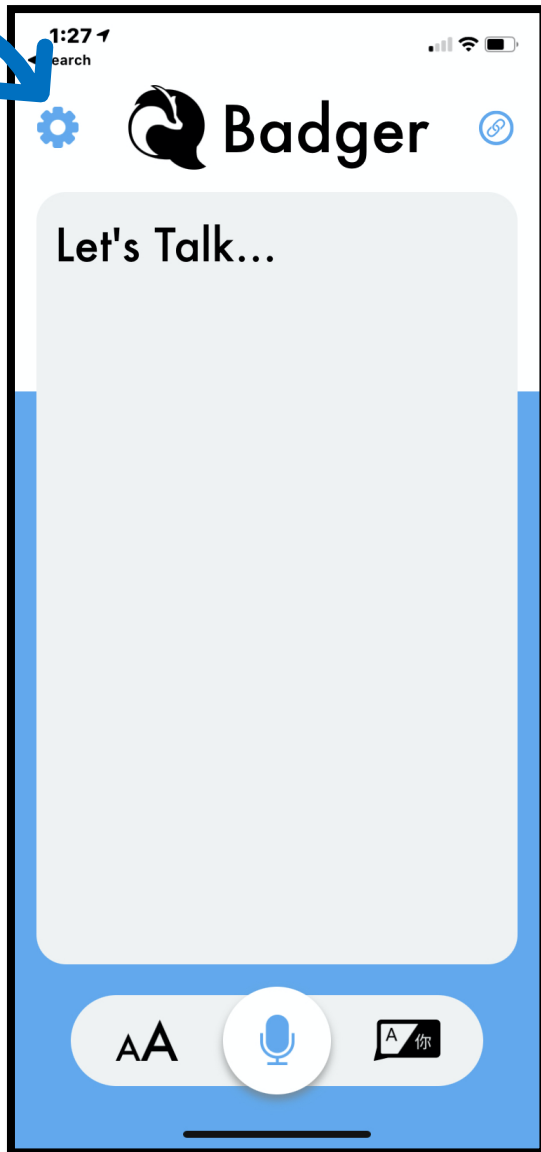

This is the screen
that comes up

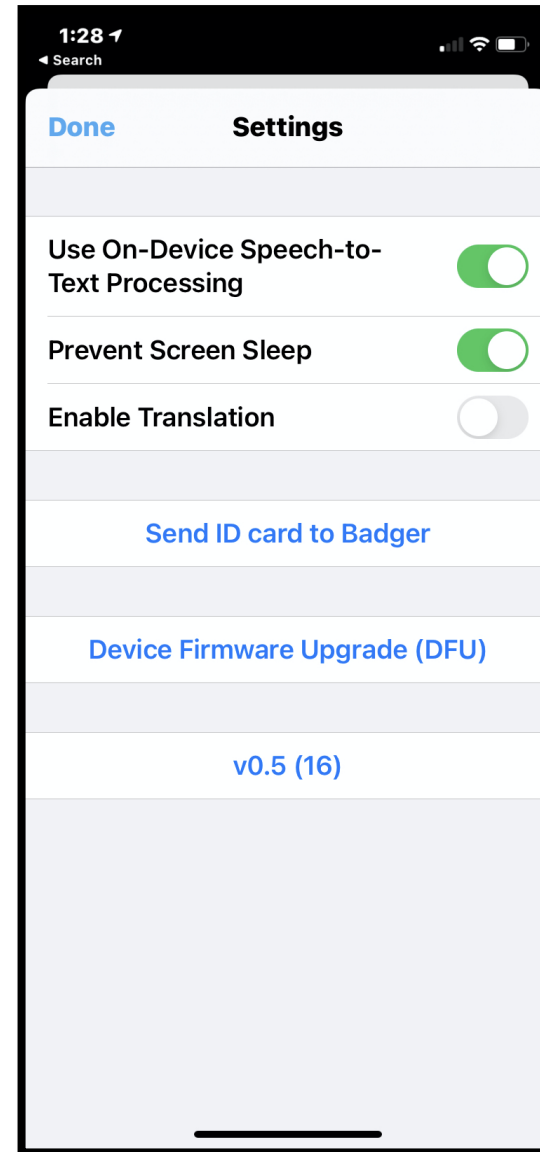

These are the
default settings

It is recommended to
use these settings first

Badger's default is
"English to English"
(speech-to-text)

If you want
translations
to work, tap
Enable Translation

Enable Translation



Font Size Setting

1

Tap Here

AA
FONT
ICON

to access
the font size

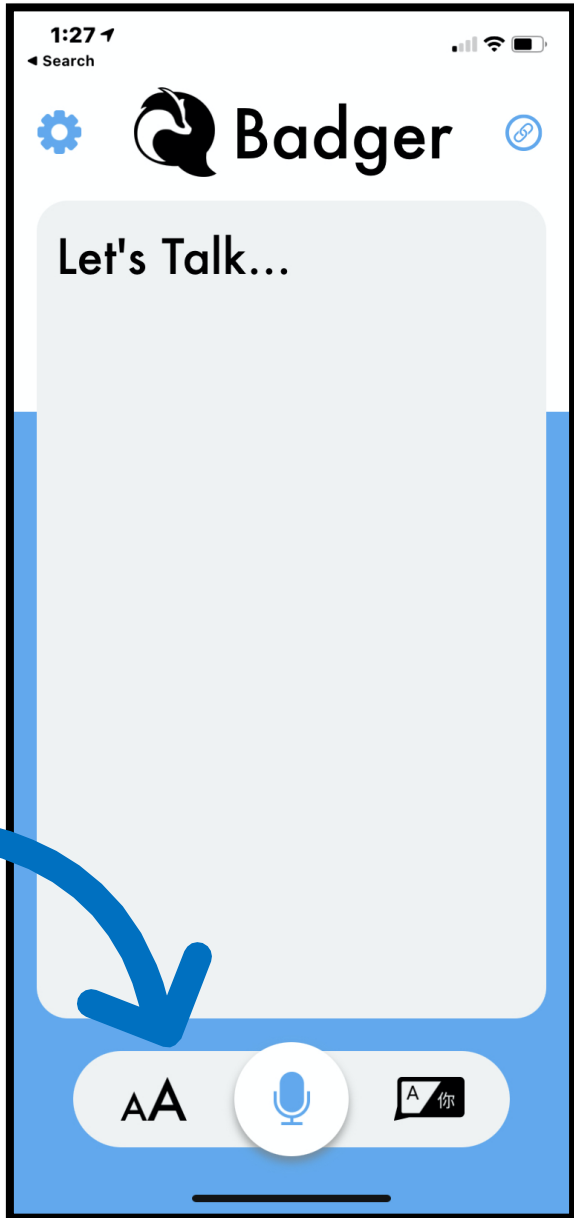

2

Slide the
white dot
to desired
font size

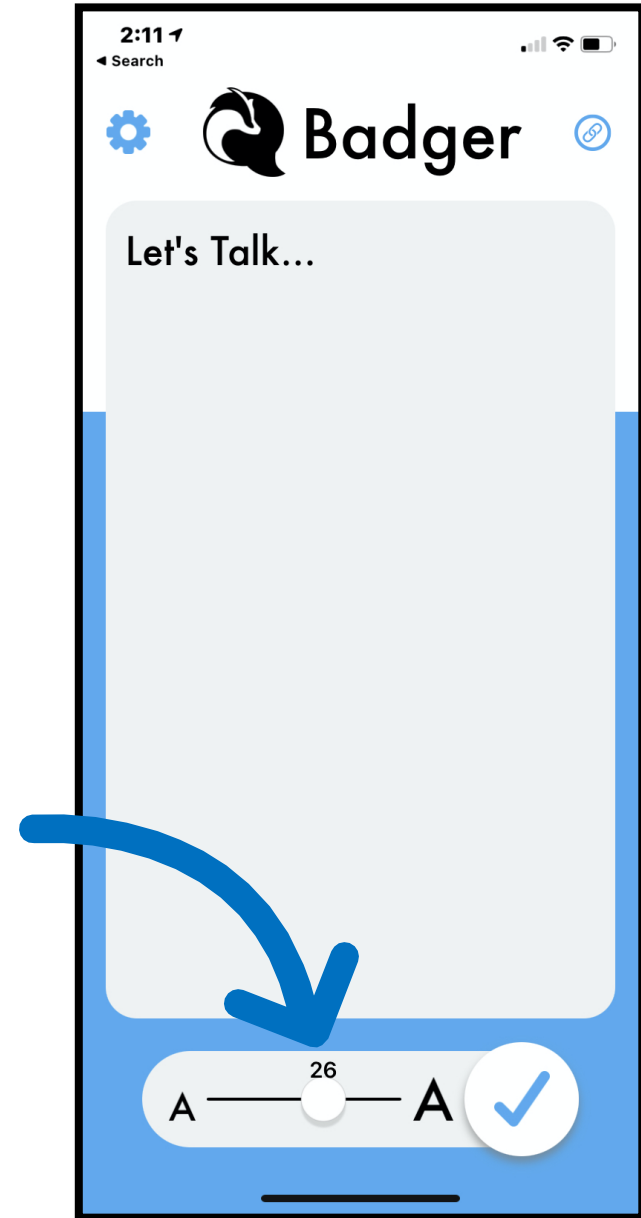

Translation (Optional Feature)

IMPORTANT! You must enable translation from the **Settings** page. View [Default Settings](#) instructions to learn how.

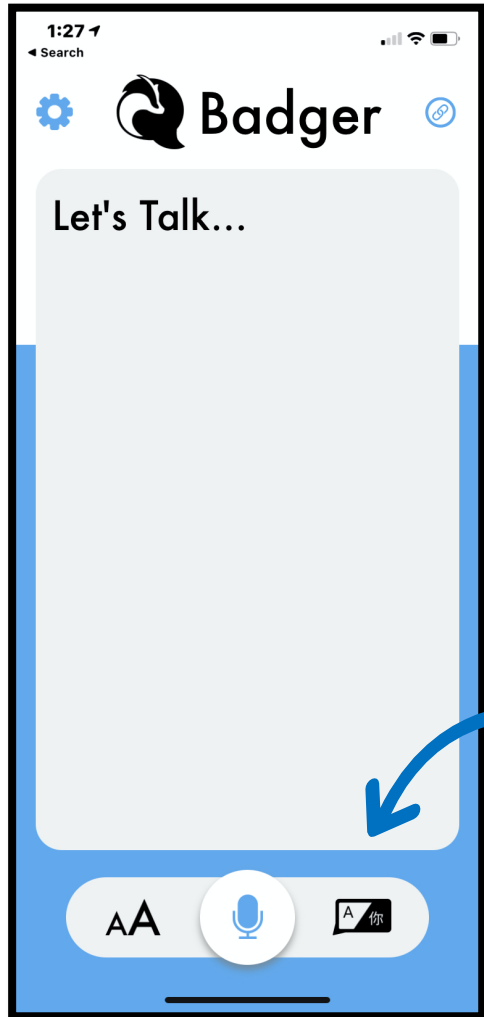

1

Tap Here



LANGUAGE ICON

to begin
translation

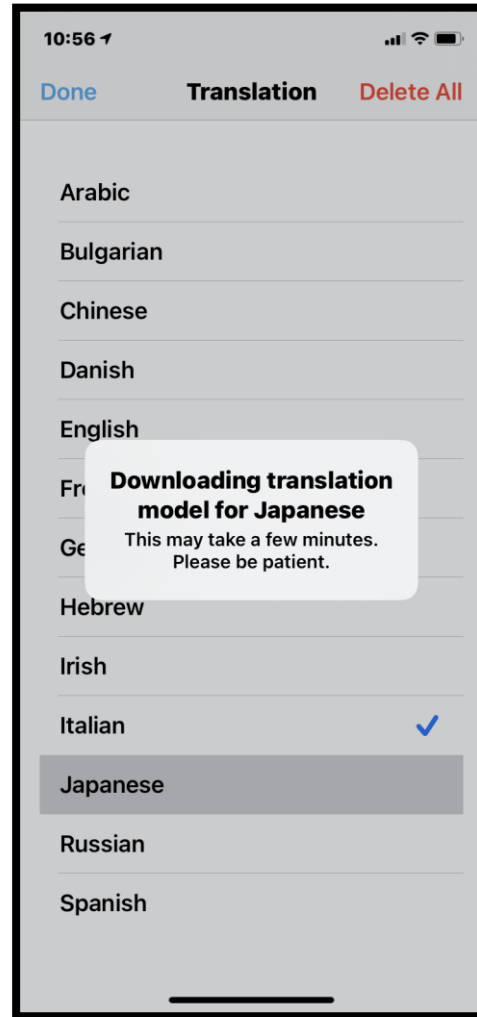

2

Select desired
language

If you select a language
you haven't used, it will
download the translation
model as shown here.

*NOTE: Internet connection required to download translation models.
If not connected to WiFi, data charges may apply.*

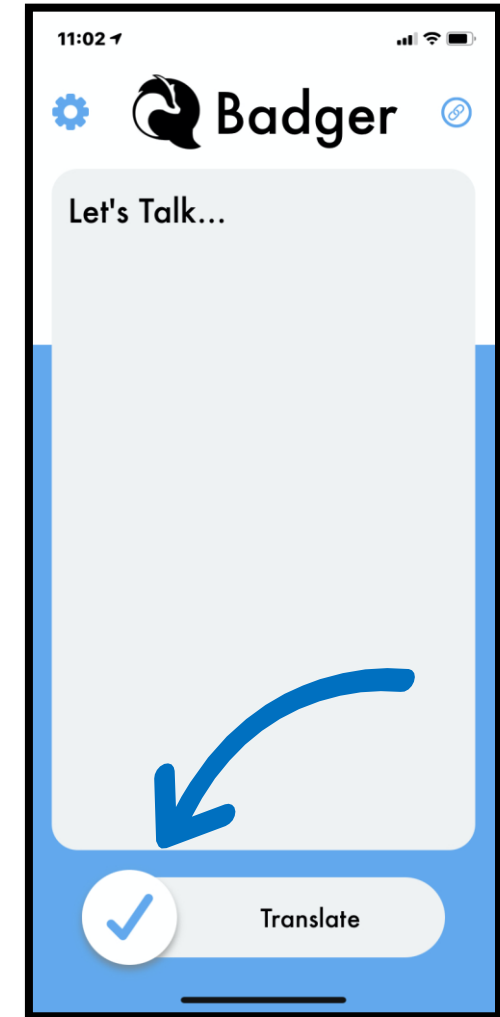

3

Tap the
checkmark
to return to
the home
screen

Charging Badger

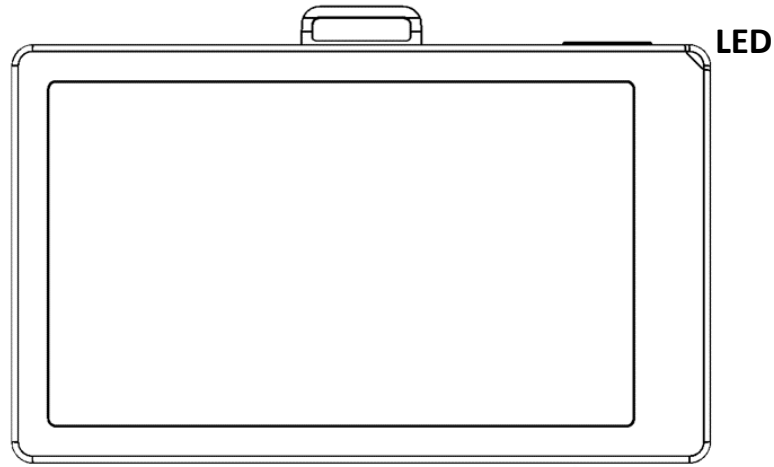

LED



FRONT VIEW

Plug the Micro USB
Charging Cord here

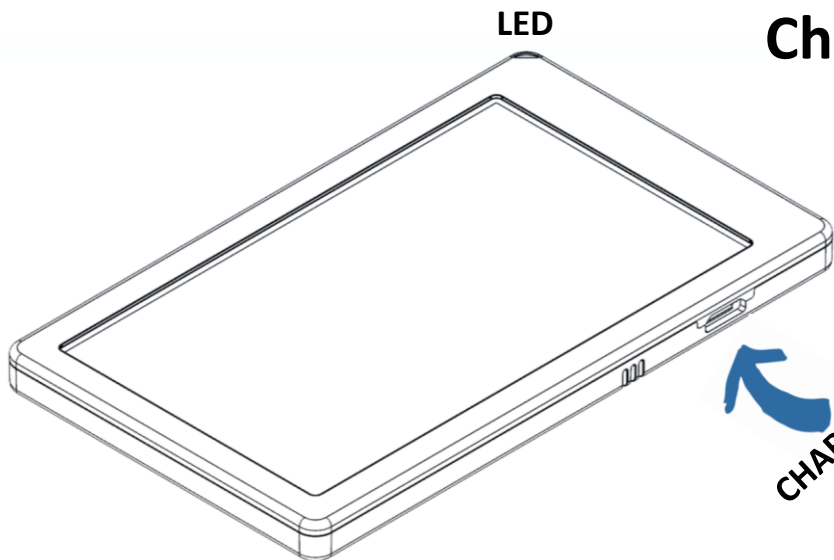

LED



CHARGING
PORT

SIDE VIEW

Plug the Micro USB
Charging Cord here

When **CHARGING**,
the LED light will be
Red

When **CHARGED**
(and still plugged in)
the LED light will be
Green

NOTE: This feature is
still in development